

KARTA TECHNICZNA

NAROŻNIK WEWNĘTRZNY KWADRATOWY

MH-MRIH

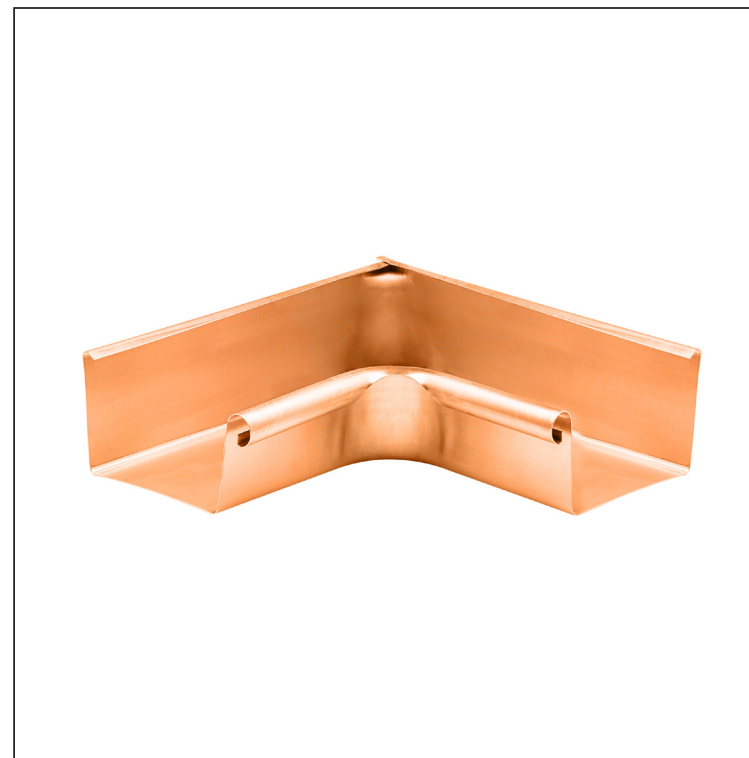

M Miedź – Natur

Wymiary [mm]					
Rozmiar nominalny	A	B	C	ØD	L
250	55	85	65	18	285
333	75	120	85	20	275

INDEKS	ZMIANA	DATA	PODPIS	KJG QUALITY®	Scan code for 3D model	
ZN. MAT			K.O.	MASA kg	SKALA	
WYM. PÓLT.				Norma STN		NR KL.
POM. URZ.		Ing. Kluska M.		ZMIAN.	NR POL.	
SPRAW.			TECHNOL.		STARY RYS.	NR RYS.
NAZWA				MH-MRIH		Arkusz
Narożnik wewnętrzny kwadratowy				Liczba arkuszy	Arkusz	

Utworzone: 06.06.2026 17:10:24

Zmiany techniczne zastrzeżone

KARTA TECHNICZNA

NAROŻNIK WEWNĘTRZNY KWADRATOWY

MH-MRIH

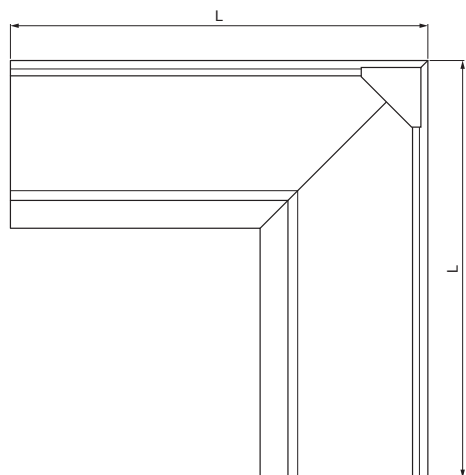
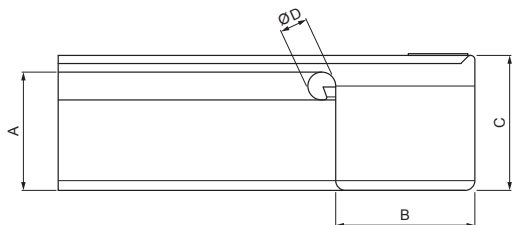

M Miedź – Natur

Wymiary [mm]					
Rozmiar nominalny	A	B	C	ØD	L
200	42	70	50	16	250
400	90	150	100	22	400

INDEKS	ZMIANA	DATA	PODPIS	KJG QUALITY®	Scan code for 3D model	
ZN. MAT			K.O.	MASA kg	SKALA	
WYM. PÓLT.				Norma STN		NR KL.
SPORZ. Ing. Kluska M.		ZMIAN.		NR POL.		
SPRAW.		STARY RYS.		NR RYS.		
TECHNOL.		TECHNOL.		NAZWA		
Narożnik wewnętrzny kwadratowy				Liczba arkuszy	MH-MRIH	Arkusze

Utworzone: 06.06.2026 17:10:24

Zmiany techniczne zastrzeżone