

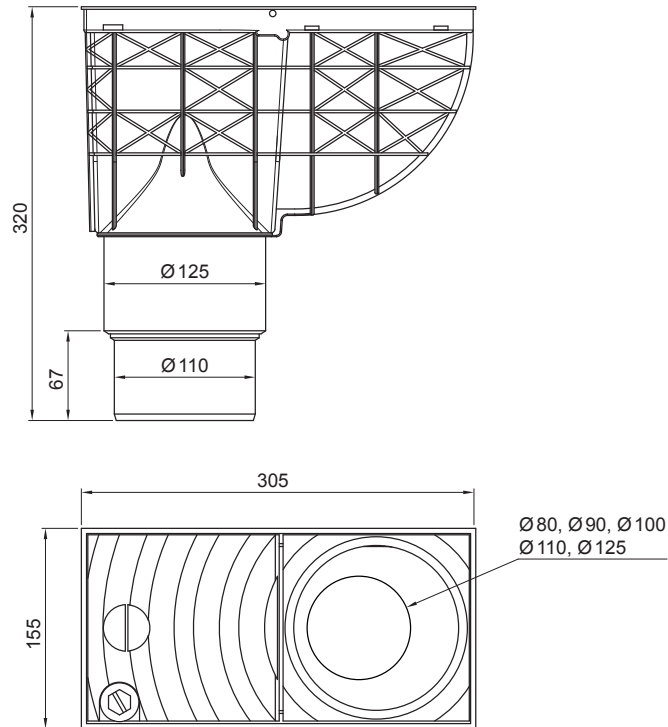



KARTA TECHNICZNA

WYJŚCIE KANALIZACYJNE

SD-KV AGV4



IC PVC – Czarny – RAL 9005

INDEKS	ZMIANA	DATA	PODPIS		
ZN. MAT	K.O.		MASA kg		
WYM. PÓLT.			Norma STN	NR KL.	
SPORZ.	Ing. Kluska M.		ZMIAN.	NR POL.	
SPRAW.			STARY RYS.	NR RYS.	
TECHNOL.	TECHNOL.				
NAZWA	Wyjście kanalizacyjne		Liczba arkuszy	SD-KV AGV4	Arkusze 

Utworzone: 19.04.2026 16:09:21

Zmiany techniczne zastrzeżone



KARTA TECHNICZNA

WYJŚCIE KANALIZACYJNE

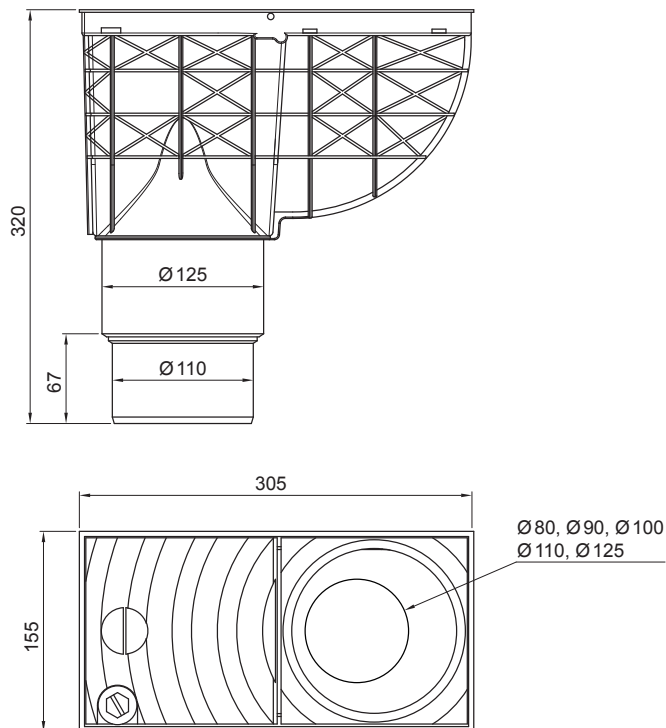
SD-KV AGV4



PS PVC – Szary – RAL 7037

INDEKS	ZMIANA	DATA	PODPIS		
ZN. MAT			K.O.	MASA kg	SKALA
WYM. PÓLT.					
POM. URZ.			Norma STN NR KL.		
SPORZ.	Ing. Kluska M.	ZMIAN.		NR POL.	
SPRAW.					
TECHNOL.		TECHNOL.	STARY RYS.	NR RYS.	
NAZWA					
Wyjście kanalizacyjne			Liczba arkuszy	SD-KV AGV4	Arkusze 

Utworzone: 19.04.2026 16:09:21

Zmiany techniczne zastrzeżone