

KARTA TECHNICZNA

KOLANO KWADRATOWE 72°

W.15H-WKH



MHM Aluminium powlekane W.15 – Ceglasty W.15 – RAL 8004

INDEKS	ZMIANA	DATA	PODPIS	KJG QUALITY®	Scan code for 3D model
ZN. MAT					
WYM. PÓLT.					
POM. URZ.				Norma STN	NR KL.
SPORZ.	Ing. Kluska M.			ZMIAN.	NR POL.
SPRAW.					
TECHNOL.	TECHNOL.			STARY RYS.	NR RYS.
NAZWA	Kolano kwadratowe 72°			Liczba arkuszy	W.15H-WKH Arkusz

Utworzone: 04.06.2026 02:42:48

Zmiany techniczne zastrzeżone

Wymiary [mm]			
Rozmiar nominalny	AxA	A1xA1	L
80/80	78 x 78	83 x 83	210
100/100	98 x 98	103 x 103	270



KARTA TECHNICZNA

KOLANO KWADRATOWE 72°

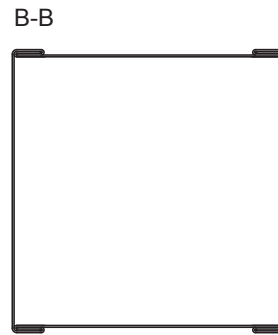
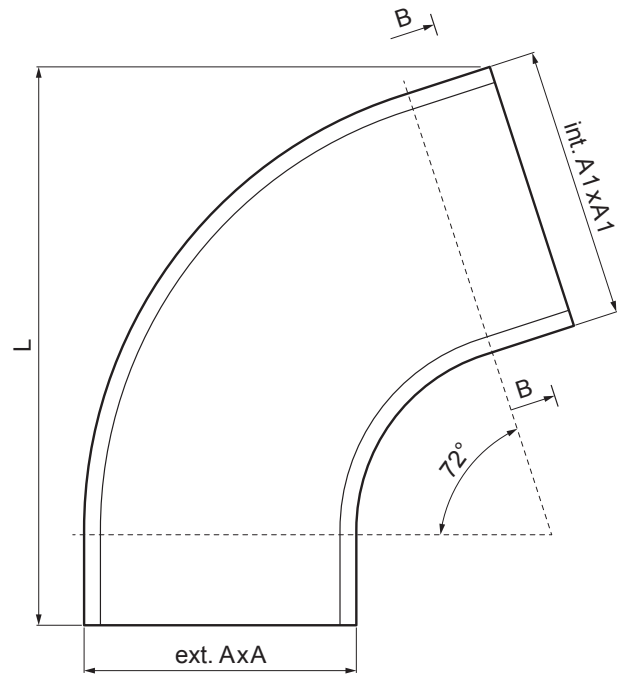
W.15H-WKH



MHM Aluminium powlekane W.15 – Ceglasty W.15 – RAL 8004

INDEKS	ZMIANA	DATA	PODPIS		
ZN. MAT					
WYM. PÓLT.			K.O.	MASA kg	SKALA
POM. URZ.				Norma STN	NR KL.
SPORZ.	Ing. Kluska M.			ZMIAN.	NR POL.
SPRAW.					
TECHNOL.	TECHNOL.			STARY RYS.	NR RYS.
NAZWA	Kolano kwadratowe 72°			Liczba arkuszy	W.15H-WKH

Utworzone: 04.06.2026 02:42:48

Zmiany techniczne zastrzeżone

Wymiary [mm]			
Rozmiar nominalny	AxA	A1xA1	L
120/120	118 x 118	123 x 123	300