

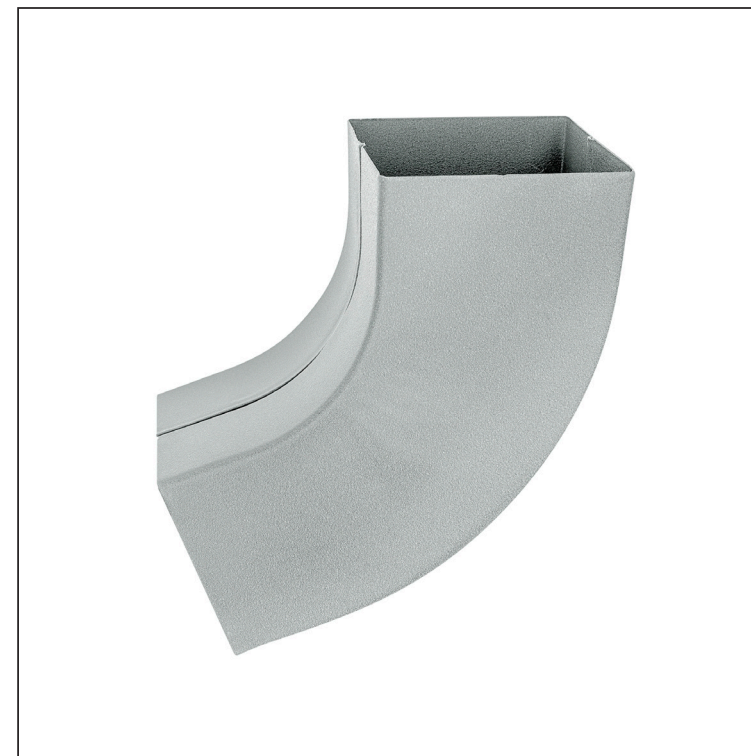

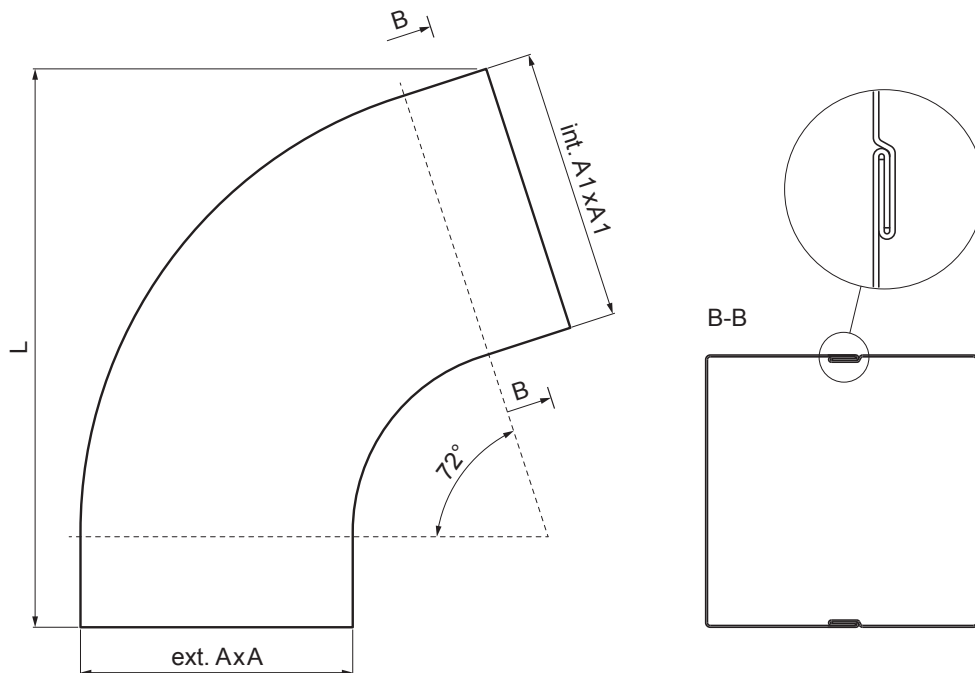

KARTA TECHNICZNA

KOLANO KWADRATOWE 72°

W.15H-WKH



ZSM Aluminium powlekane W.15 – Cynkowo szary W.15 – RAL extra

INDEKS	ZMIANA	DATA	PODPIS	  		
ZN. MAT.						
WYM. PÓLT.			K.O.	MASA kg	SKALA	
POM. URZ.				Norma STN	NR KL.	
SPORZ.	Ing. Kluska M.			ZMIAN.	NR POL.	
SPRAW.						
TECHNOL.	TECHNOL.			STARY RYS.	NR RYS.	
NAZWA	Kolano kwadratowe 72°			Liczba arkuszy	W.15H-WKH	Arkusze 

Utworzone: 20.04.2026 14:24:42

Zmiany techniczne zastrzeżone

Wymiary [mm]			
Rozmiar nominalny	AxA	A1xA1	L
80/80	78 x 78	83 x 83	210
100/100	98 x 98	103 x 103	270



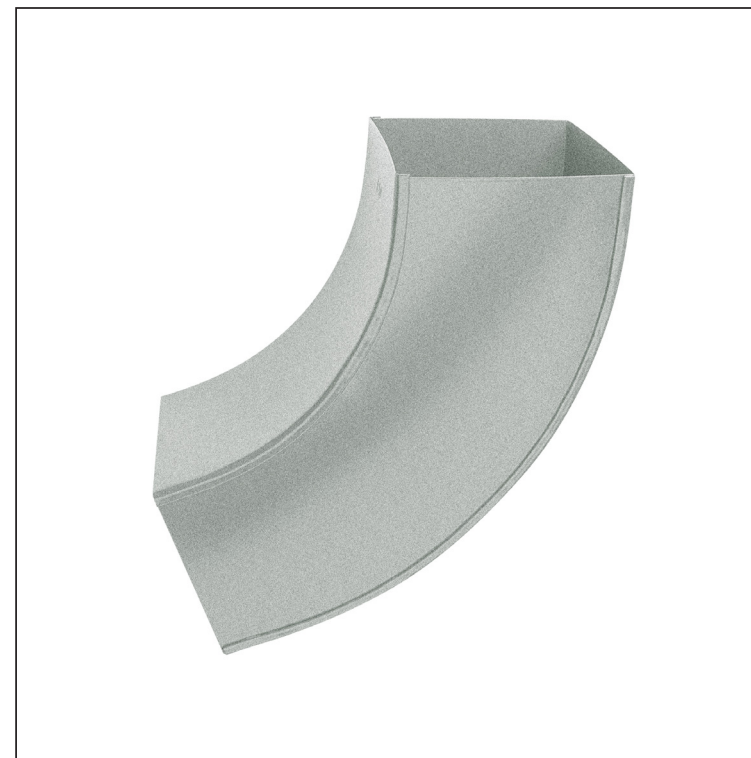

KARTA TECHNICZNA

KOLANO KWADRATOWE 72°

W.15H-WKH



ZSM Aluminium powlekane W.15 – Cynkowo szary W.15 – RAL extra

INDEKS	ZMIANA	DATA	PODPIS			
ZN. MAT	K.O.		MASA kg			
WYM. PÓLT.				Norma STN	NR KL.	
POM. URZ.				ZMIAN.	NR POL.	
SPORZ.	Ing. Kluska M.			STARY RYS.	NR RYS.	
SPRAW.						
TECHNOL.	TECHNOL.					
NAZWA	Kolano kwadratowe 72°			Liczba arkuszy	W.15H-WKH	Arkusze 

Utworzone: 20.04.2026 14:24:42

Zmiany techniczne zastrzeżone

Wymiary [mm]			
Rozmiar nominalny	AxA	A1xA1	L
120/120	118 x 118	123 x 123	300