

KARTA TECHNICZNA

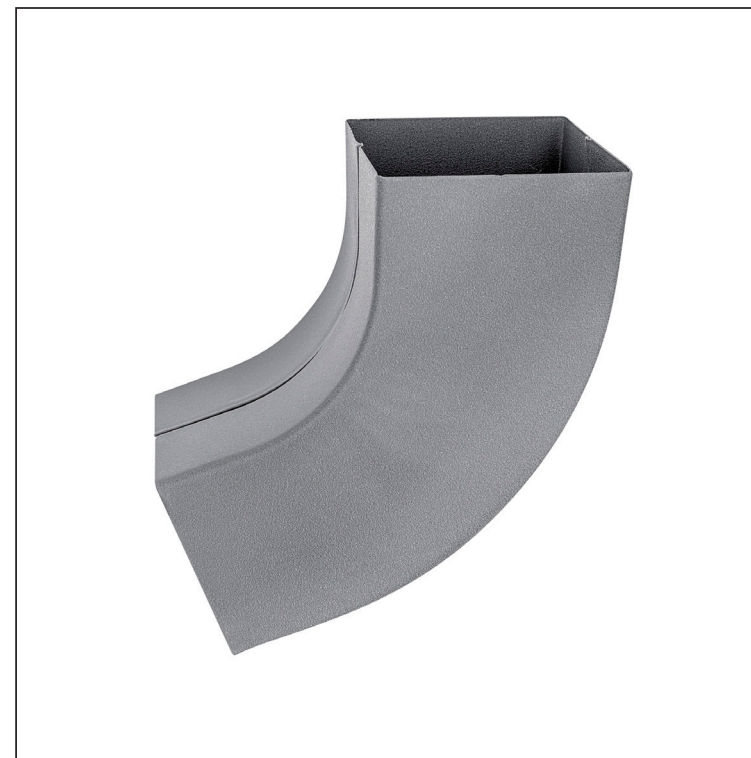

KOLANO KWADRATOWE 72°

W.15H-WKH

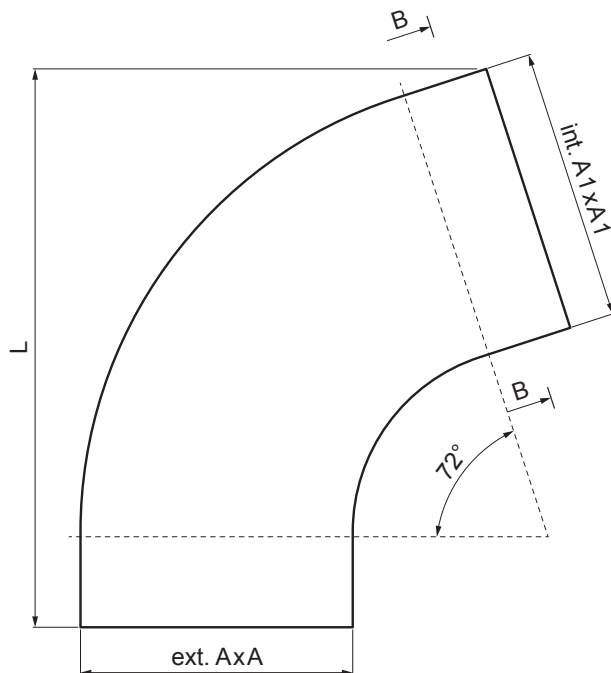

SSM Aluminium powlekane W.15 – Jasnoszary W.15 – RAL 7005

Wymiary [mm]			
Rozmiar nominalny	AxA	A1xA1	L
80/80	78 x 78	83 x 83	210
100/100	98 x 98	103 x 103	270

INDEKS	ZMIANA	DATA	PODPIS	  
ZN. MAT	K.O.		MASA kg	
WYM. PÓLT.			Norma STN	NR KL.
POM. URZ.			ZMIAN.	NR POL.
SPORZ. Ing. Kluska M.			STARY RYS.	NR RYS.
SPRAW.				
TECHNOL.	TECHNOL.			
NAZWA	Kolano kwadratowe 72°		Liczba arkuszy	W.15H-WKH Arkusz

Utworzone: 04.06.2026 02:42:52

Zmiany techniczne zastrzeżone



KARTA TECHNICZNA

KOLANO KWADRATOWE 72°

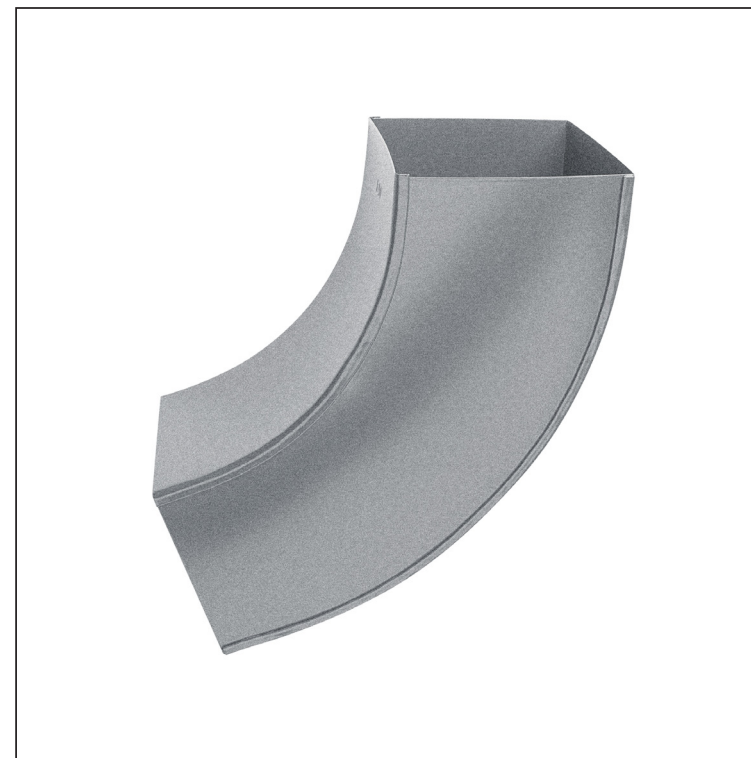
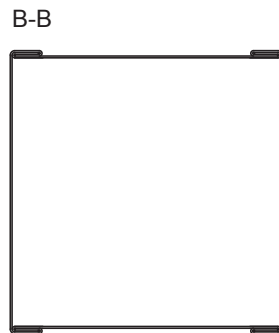
W.15H-WKH



SSM Aluminium powlekane W.15 – Jasnoszary W.15 – RAL 7005

INDEKS	ZMIANA	DATA	PODPIS	  
ZN. MAT				
WYM. PÓLT.		K.O.	MASA kg	SKALA
POM. URZ.			Norma STN	NR KL.
SPORZ.	Ing. Kluska M.		ZMIAN.	NR POL.
SPRAW.				
TECHNOL.	TECHNOL.		STARY RYS.	NR RYS.
NAZWA	Kolano kwadratowe 72°		Liczba arkuszy	W.15H-WKH

Wymiary [mm]			
Rozmiar nominalny	AxA	A1xA1	L
120/120	118 x 118	123 x 123	300

Utworzone: 04.06.2026 02:42:52

Zmiany techniczne zastrzeżone