

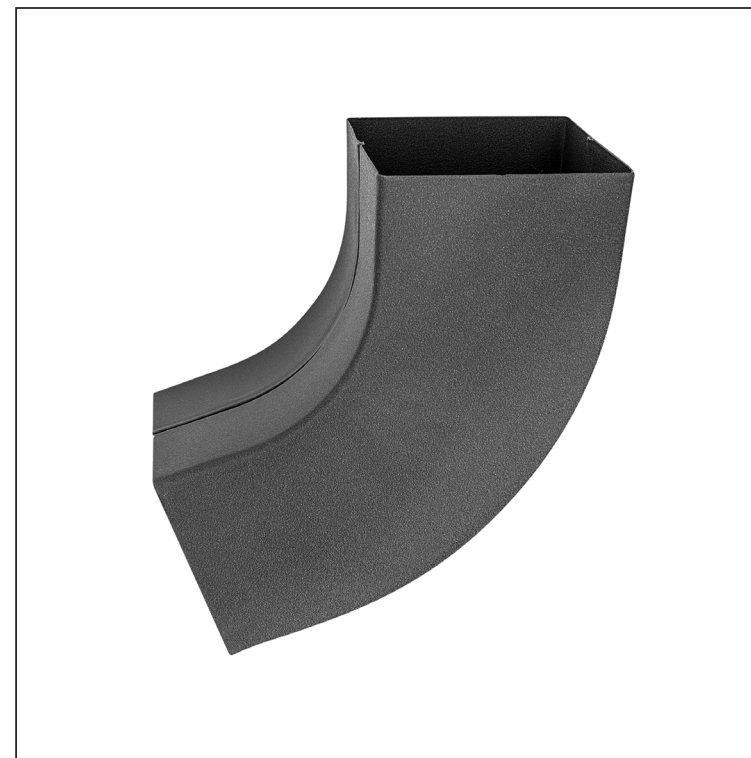

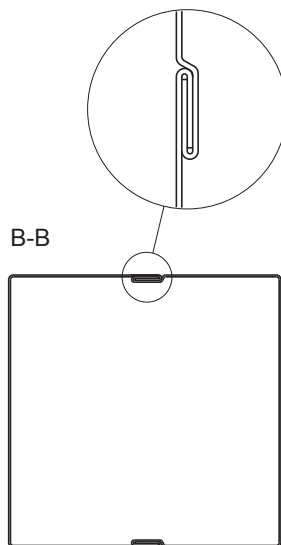
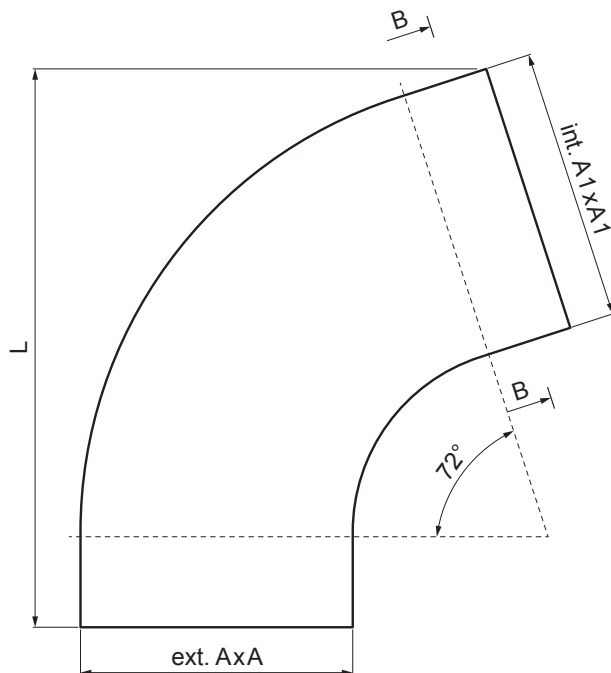

KARTA TECHNICZNA

# KOLANO KWADRATOWE 72°

## W.15H-WKH



**ANM** Aluminium powlekane W.15 – Antracyt W.15 – RAL 7016

INDEKS	ZMIANA	DATA	PODPIS	  		
ZN. MAT.						
WYM. PÓLT.			K.O.	MASA kg	SKALA	
POM. URZ.				Norma STN	NR KL.	
SPORZ.	Ing. Kluska M.			ZMIAN.	NR POL.	
SPRAW.						
TECHNOL.	TECHNOL.			STARY RYS.	NR RYS.	
NAZWA	Kolano kwadratowe 72°			Liczba arkuszy	W.15H-WKH	Arkusze 

Utworzone: 03.12.2025 16:59:45

Zmiany techniczne zastrzeżone

Wymiary [mm]			
Rozmiar nominalny	AxA	A1xA1	L
100/100	98 x 98	103 x 103	270