

KARTA TECHNICZNA

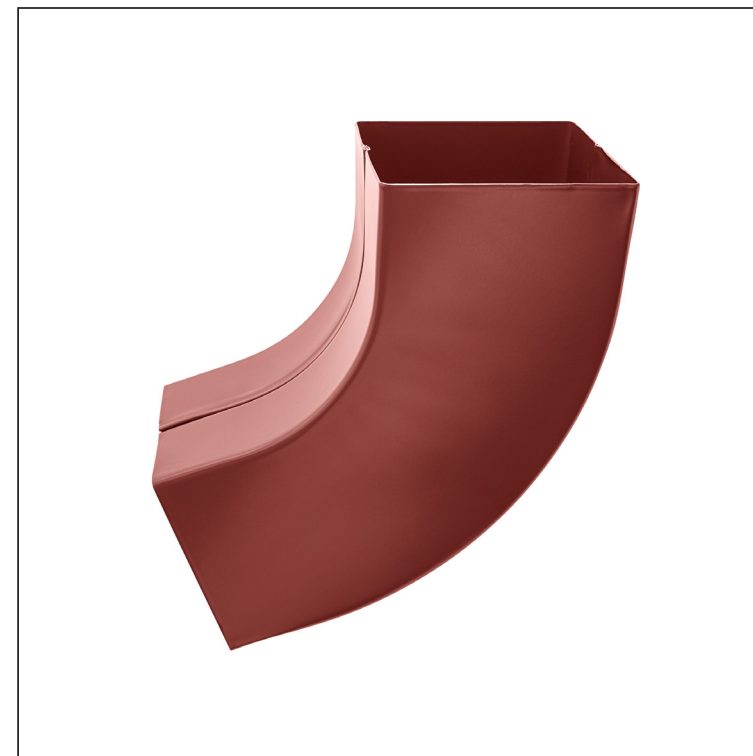

# KOLANO KWADRATOWE 72°

WH-WKH

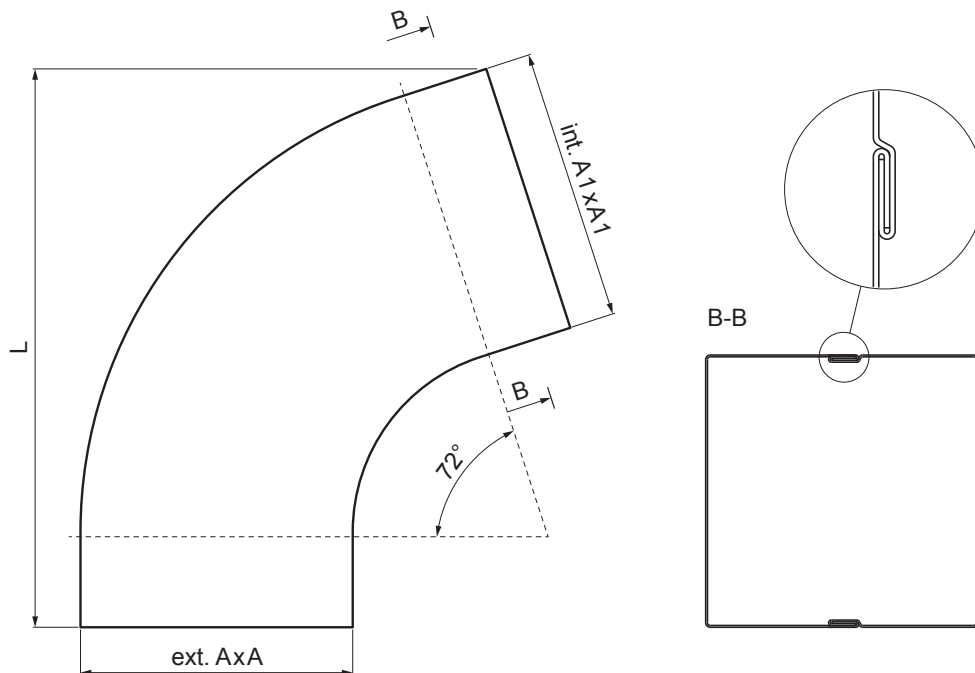

**OC** Aluminium powlekane – Czerwony – RAL 3009

Wymiary [mm]			
Rozmiar nominalny	AxA	A1xA1	L
80/80	78 x 78	83 x 83	210
100/100	98 x 98	103 x 103	270

INDEKS	ZMIANA	DATA	PODPIS	  
ZN. MAT				
WYM. PÓLT.			K.O.	MASA kg
POM. URZ.				SKALA
SPORZ.	Ing. Kluska M.			Norma STN
SPRAW.				NR KL.
TECHNOL.				ZMIAN.
NAZWA				NR POL.
				STARY RYS.
				NR RYS.
				NAZWA
				Kolano kwadratowe 72°
				Liczba arkuszy
				WH-WKH
				Arkusze

Utworzone: 20.04.2026 00:00:27

Zmiany techniczne zastrzeżone



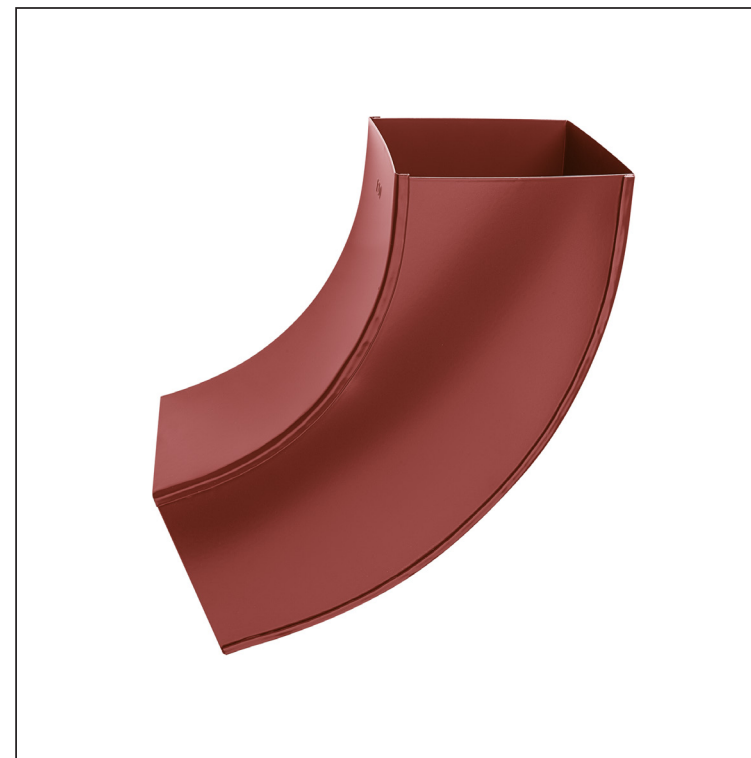

KARTA TECHNICZNA

# KOLANO KWADRATOWE 72°

WH-WKH



**OC** Aluminium powlekane – Czerwony – RAL 3009

INDEKS	ZMIANA	DATA	PODPIS			
ZN. MAT.	K.O.		MASA kg			
WYM. PÓLT.				Norma STN	NR KL.	
POM. URZ.				ZMIAN.	NR POL.	
SPORZ.	Ing. Kluska M.			STARY RYS.	NR RYS.	
SPRAW.						
TECHNOL.	TECHNOL.					
NAZWA	Kolano kwadratowe 72°			Liczba arkuszy	WH-WKH	Arkusze 

Utworzone: 20.04.2026 00:00:27

Zmiany techniczne zastrzeżone

Wymiary [mm]			
Rozmiar nominalny	AxA	A1xA1	L
120/120	118 x 118	123 x 123	300