

KARTA TECHNICZNA

KOLANO KWADRATOWE 72°

WH-WKH

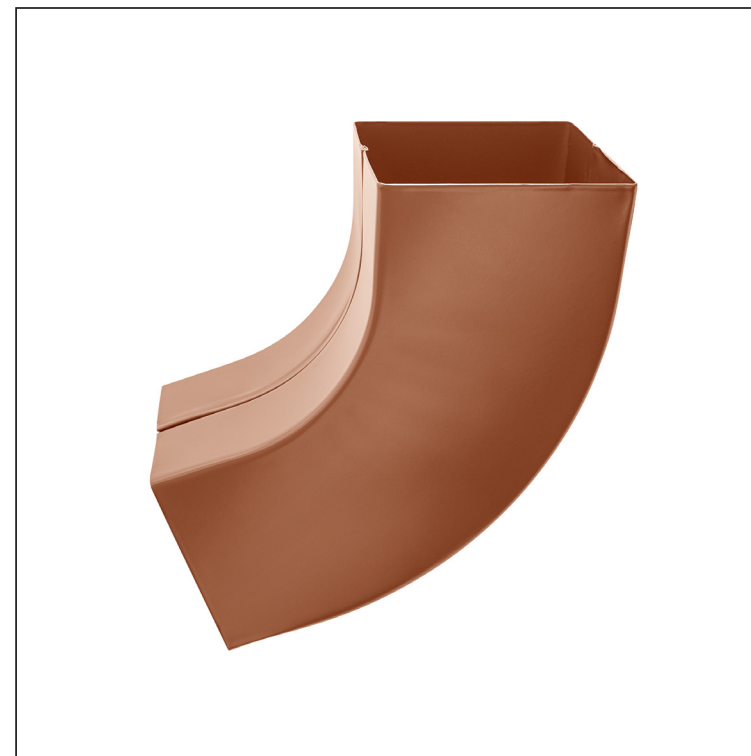

MH Aluminium powlekane – Ceglasty – RAL 8004

INDEKS	ZMIANA	DATA	PODPIS	KJG QUALITY®	Scan code for 3D model
ZN. MAT	K.O.		MASA kg		
WYM. PÓLT.			Norma STN	NR KL.	
POM. URZ.			ZMIAN.	NR POL.	
SPORZ.	Ing. Kluska M.		STARY RYS.	NR RYS.	
SPRAW.					
TECHNOL.	TECHNOL.				
NAZWA	Kolano kwadratowe 72°			Liczba arkuszy	WH-WKH Arkusz

Utworzone: 05.06.2026 17:06:54

Zmiany techniczne zastrzeżone

Wymiary [mm]			
Rozmiar nominalny	AxA	A1xA1	L
80/80	78 x 78	83 x 83	210
100/100	98 x 98	103 x 103	270



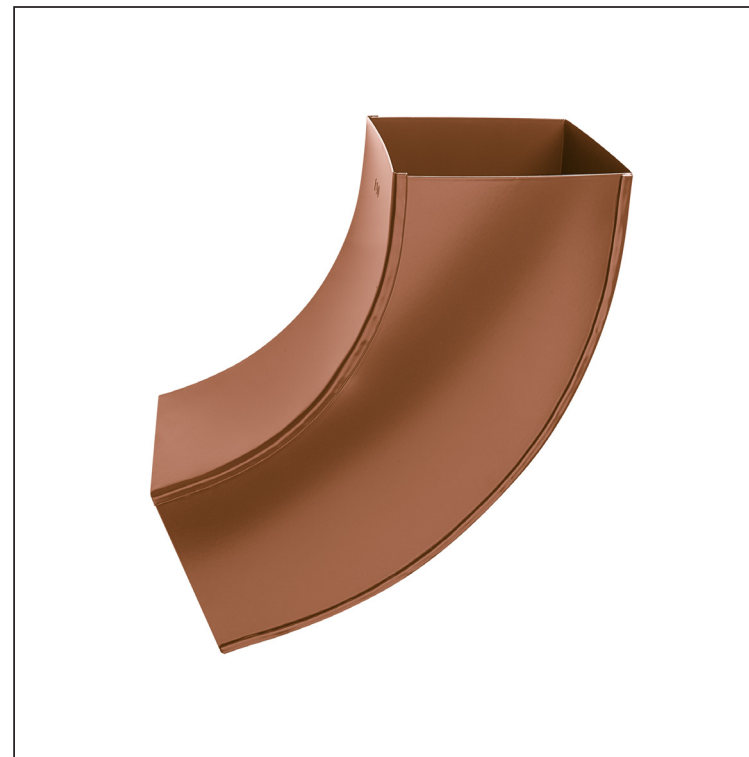

KARTA TECHNICZNA

KOLANO KWADRATOWE 72°

WH-WKH



MH Aluminium powlekane – Ceglasty – RAL 8004

INDEKS	ZMIANA	DATA	PODPIS			
ZN. MAT.	K.O.		MASA kg			
WYM. PÓLT.				Norma STN	NR KL.	
POM. URZ.				ZMIAN.	NR POL.	
SPORZ.	Ing. Kluska M.			STARY RYS.	NR RYS.	
SPRAW.						
TECHNOL.	TECHNOL.					
NAZWA	Kolano kwadratowe 72°			Liczba arkuszy	WH-WKH	Arkusze 

Utworzone: 05.06.2026 17:06:54

Zmiany techniczne zastrzeżone

Wymiary [mm]			
Rozmiar nominalny	AxA	A1xA1	L
120/120	118 x 118	123 x 123	300