

KARTA TECHNICZNA

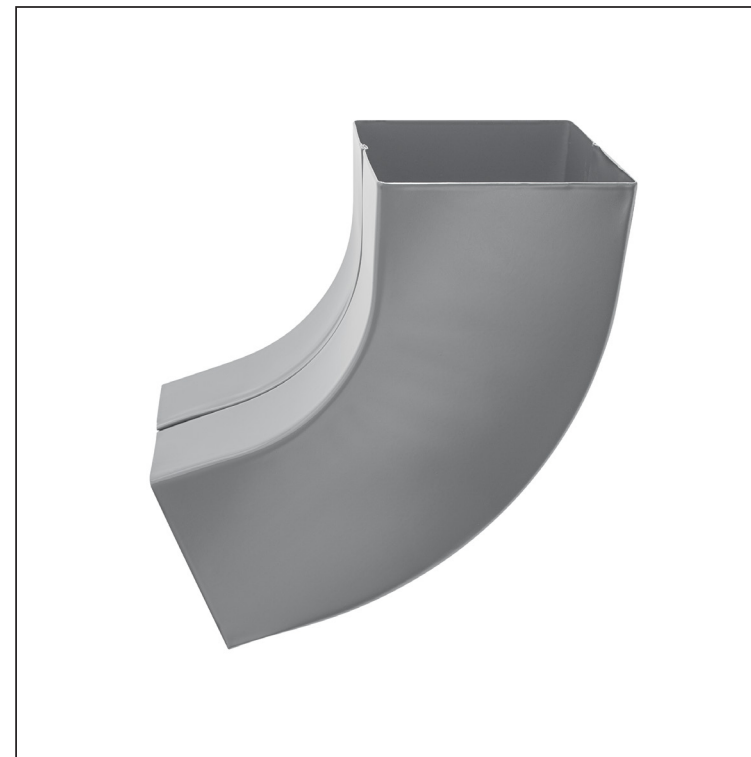



# KOLANO KWADRATOWE 72°

WH-WKH



**SS** Aluminium powlekane – Jasnoszary – RAL 7005

Wymiary [mm]			
Rozmiar nominalny	AxA	A1xA1	L
80/80	78 x 78	83 x 83	210
100/100	98 x 98	103 x 103	270

INDEKS	ZMIANA	DATA	PODPIS				
ZN. MAT.							K.O.
WYM. PÓLT.							
POM. URZ.						Norma STN	NR KL.
SPORZ.	Ing. Kluska M.					ZMIAN.	NR POL.
SPRAW.							
TECHNOL.		TECHNOL.				STARY RYS.	NR RYS.
NAZWA	Kolano kwadratowe 72°					Liczba arkuszy	WH-WKH
							Arkuszy 

Utworzone: 20.04.2026 22:56:24

Zmiany techniczne zastrzeżone



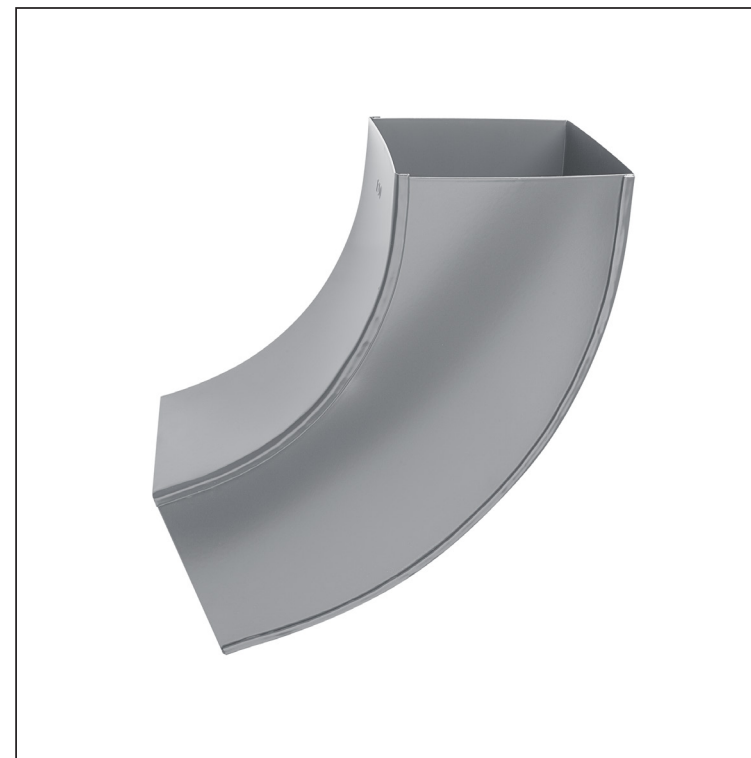

KARTA TECHNICZNA

# KOLANO KWADRATOWE 72°

# WH-WKH



**SS** Aluminium powlekane – Jasnoszary – RAL 7005

INDEKS	ZMIANA	DATA	PODPIS			
ZN. MAT.	K.O.		MASA kg			
WYM. PÓLT.				Norma STN	NR KL.	
POM. URZ.				ZMIAN.	NR POL.	
SPORZ.	Ing. Kluska M.			STARY RYS.	NR RYS.	
SPRAW.						
TECHNOL.	TECHNOL.					
NAZWA	Kolano kwadratowe 72°			Liczba arkuszy	WH-WKH	Arkusz 

Utworzone: 20.04.2026 22:56:24

Zmiany techniczne zastrzeżone

Wymiary [mm]			
Rozmiar nominalny	AxA	A1xA1	L
120/120	118 x 118	123 x 123	300